

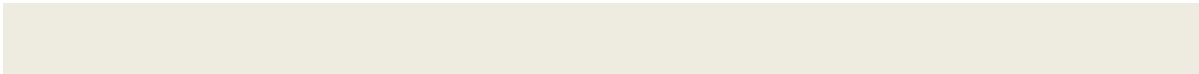

DG H LDI G C ., L D.



C . D D D A

DG H LDI G C ., L D.

L D

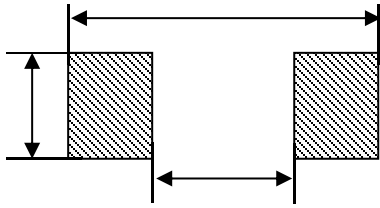

-
-

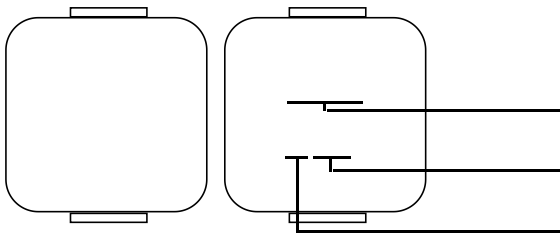

.	I		DC ()		C	H
	μ				I (A .)	I (A .)

:

:

(),

()

I

. DC C

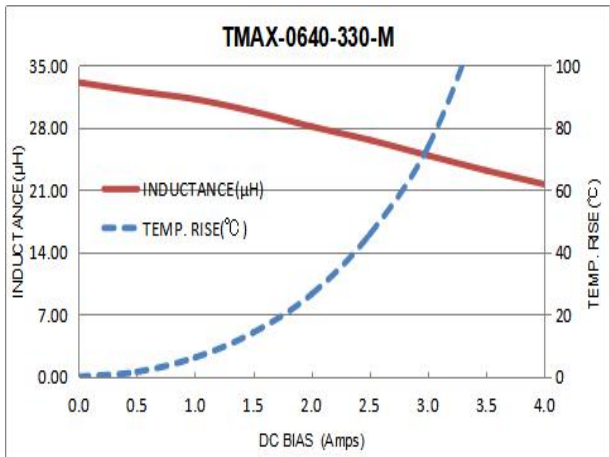
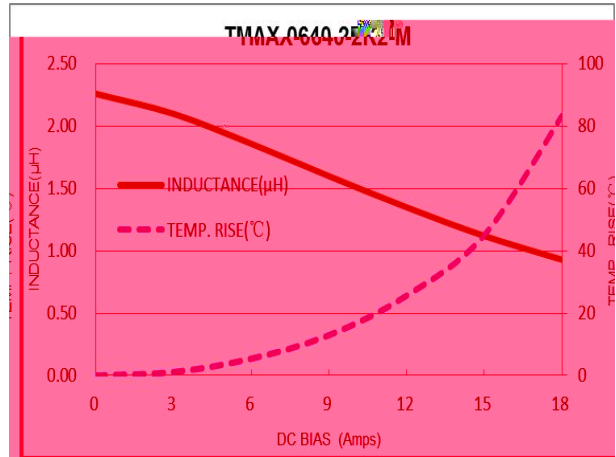
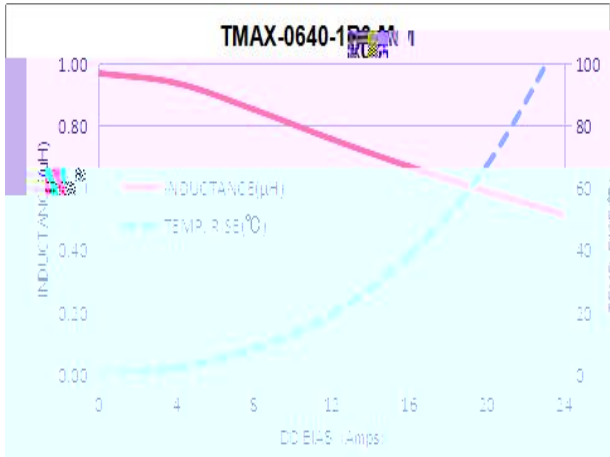

:

I

±
± °C ±

±

:

I		
	$\begin{matrix} \pm & \pm & \rightarrow \\ & & \rightarrow \pm \\ \pm & \rightarrow & \end{matrix}$	
	\pm	\pm
	\pm	
	\pm	
	\pm	

D

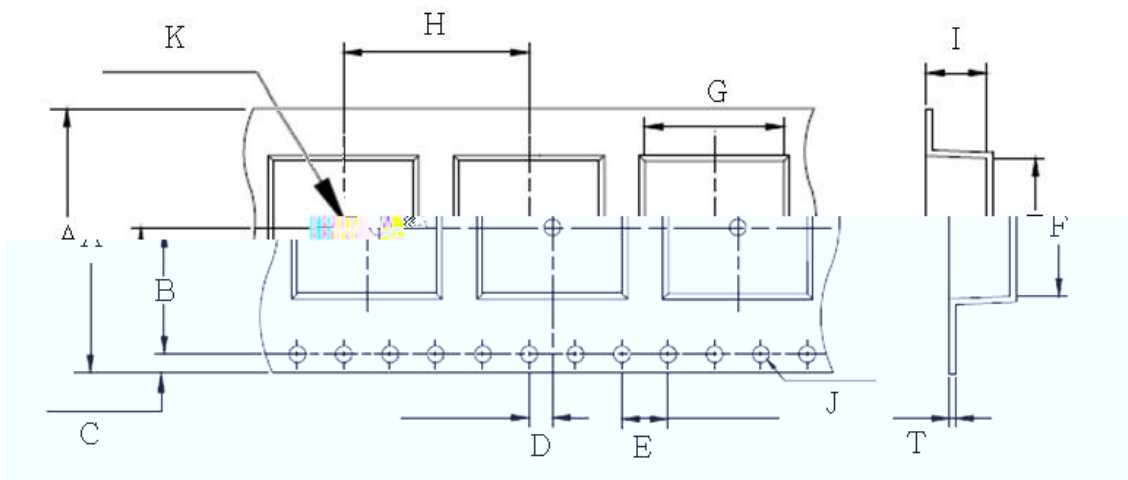

±	±	±	±	±	±
±	±	±	±	±	±

D

±	±	

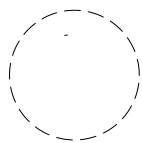

-
-

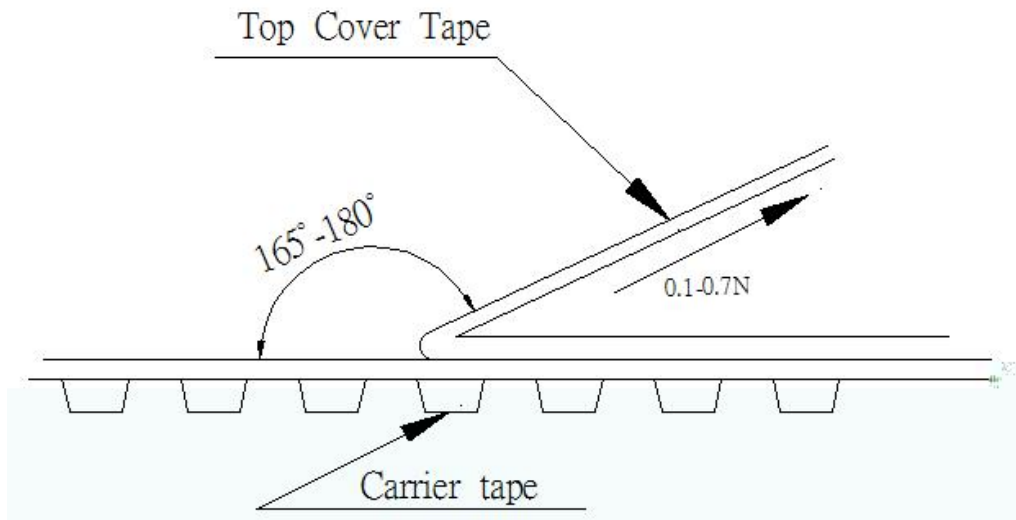

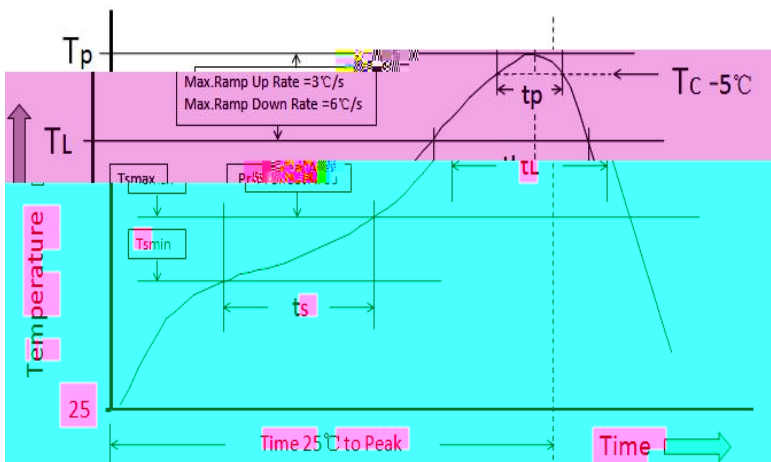

1- ()

	³ <350	³ ≅ 350
<	°C	°C
≅	°C	°C

2-L ()F ()

	³ <350	³ 350-2000	³ >2000
<	°C	°C	°C
	°C	°C	°C
	°C	°C	°C

JDEC J- D-020()

F	L ()F
	°C
	°C
	°C
	°C
	°C
°C	
	°C
°C	

●

└

●

●

L

L

✓

✓

✓

✓

✓

✓

✓

✓

✓

✓

C

C

➤

➤

✓

✓

✓

✓

➤

➤ D

C

➤

➤

➤

➤

➤

➤

➤